

INSTRUCTIONS ON INSTALLING ARTLIGHTS - ALH04 ALL MODELS

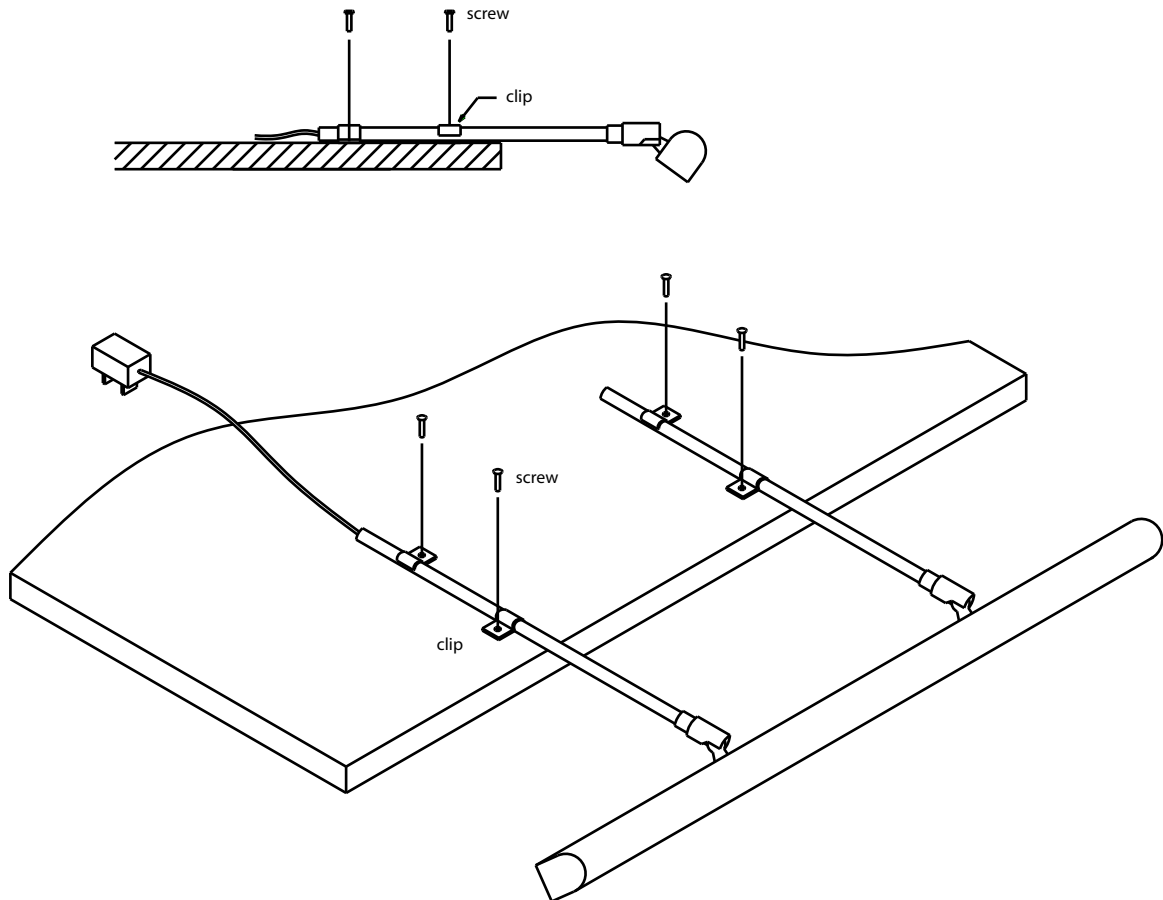

INSTRUCTIONS ON CHANGING BULBS

All models except Artlight P2 (AL10)

- Step 1** Turn knob or screw counter clockwise
- Step 2** Lift bracket to vertical position
- Step 3** Always hold bulbs with enclosed plastic envelope. Insert bulb into socket. Push and turn clockwise until it locks
- Step 4** Push bracket back to horizontal position and refasten screw

